

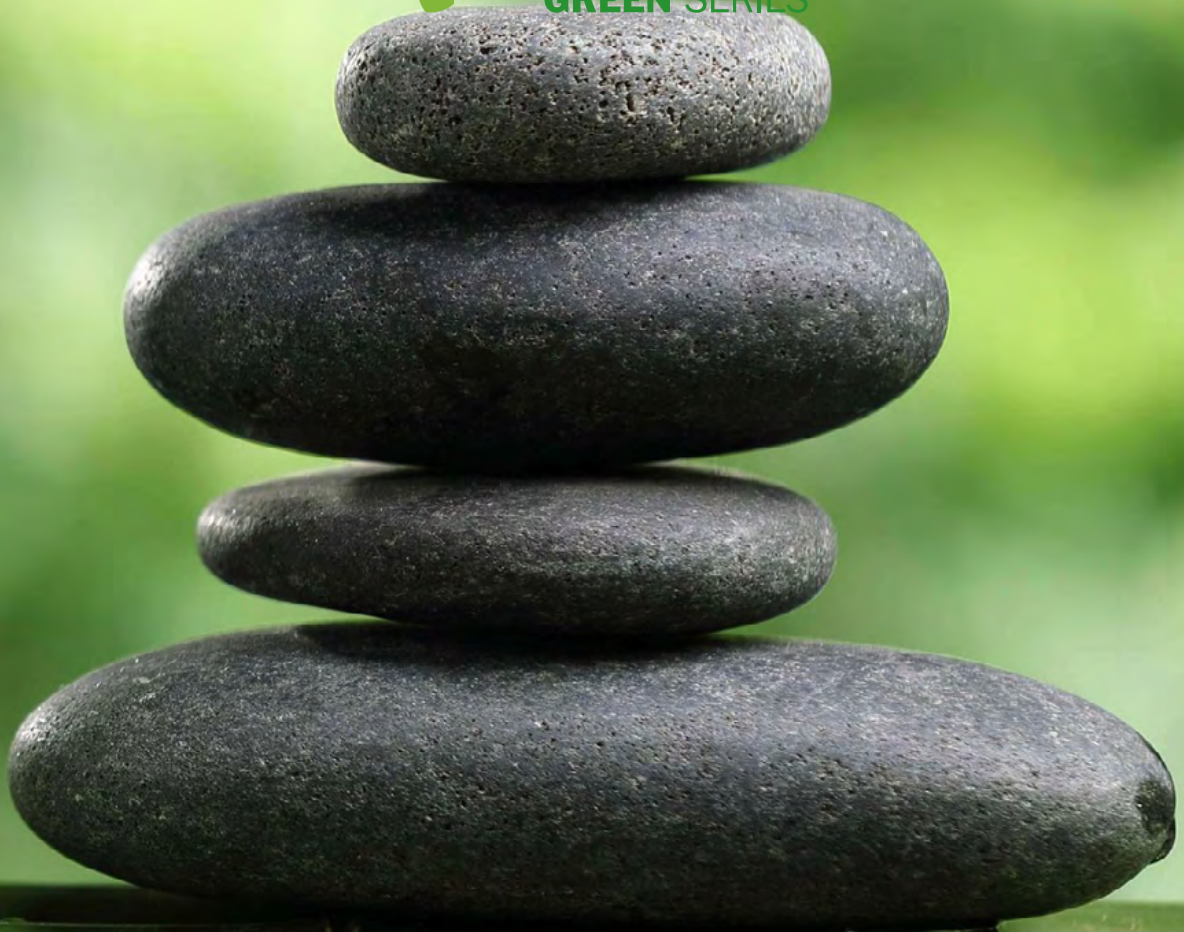

ECO SEAT
EURO SEATING
GREEN SERIES



COLORS SEAT
EURO SEATING
RAINBOW SERIES



"If you truly love

nature,

you will find beauty everywhere."

(Vicent Van Gogh)

"Si realmente amas la

naturaleza,

encontraras la belleza en todas partes."

(Vicent Van Gogh)



La gestión sostenible comienza por el **diseño**

Conseguir una **nueva forma de concebir productos** no es un trabajo fácil. Es necesario conocer el comportamiento ambiental de nuestros productos, **investigar nuevas formas** de concepción y de desarrollo alternativas, aprender de los logros que ofrece el constante **desarrollo tecnológico**... En definitiva, es necesario **innovar** en el trabajo del **día a día, incorporando el medio ambiente como un factor más** a tener en cuenta en el diseño de los productos. Es necesario "ecodiseñar" nuestros productos.

*Sustainable manage- ment begins with **design***

*Achieving a **new way of conceiving products** is not an easy job. It is necessary to know the environmental performance of our products, to **investigate new ways** of alternative conception and development, to learn from the achievements that the continuous **technological development** offers ... In the end, there is a need for **innovation** in our **day-to-day work, incorporating the environment as another factor** to take into account in the design of the products. It is necessary to "ecodesign" our products.*



Ecodiseño / Ecodesign

Gestión ambiental del proceso de diseño y desarrollo
Environmental management of the process of design and development
ISO 14006

¿Que se entiende por Ecodiseño?

Ecodiseñar es **identificar**, en el momento mismo en que se proyecta un producto/servicio, todos **los impactos ambientales** que se pueden producir en cada una de las fases de su ciclo de vida, con el fin de **intentar reducirlos** al mínimo, **sin menoscabo de su calidad** y aplicaciones.

El certificado de Ecodiseño de AENOR demuestra que la organización ha adoptado un sistema de gestión para **identificar, controlar y mejorar de manera continua los aspectos ambientales de sus productos y/o servicios** facilitando información a sus clientes sobre los productos que han incorporado **mejoras ambientales a través del diseño**, de acuerdo con la norma UNE-EN ISO 14006. Gestión ambiental del proceso de diseño y desarrollo, Ecodiseño

What is the meaning of Ecodesign?

To *ecodesign* is to identify, when a product/service is planned, all the **environmental impacts** that it can produce in each of the stages of its life cycle, in order to try to **reduce them** to the minimum, **without having an adverse effect on quality** and the product's applications.

AENOR's Ecodesign certificate demonstrates that the organisation has adopted a system of management to **identify, monitor and constantly improve its products' and/or services' environmental aspects**, providing information to its clients on products that have incorporated **environmental improvements via their design**, in accordance with the specifications of UNE-EN ISO 14006. Environmental management of the process of design and development, Ecodesign.



Ventajas.

La certificación de **Ecodiseño** ofrece a la organización la posibilidad de:

- Anticiparse en el cumplimiento de la **legislación ambiental** vigente.
- Acceder a **nuevos mercados** más exigentes.
- **Mejorar la imagen** del producto y de la empresa.
- Mejorar el cumplimiento de los requisitos demandados por las partes interesadas (administración, clientes, consumidores) para una **economía más sostenible**.
- **Distinguirse** de sus competidores.
- **Reducir costes** de producción.
- **Impulsar productos innovadores**.
- **Posicionarse de manera privilegiada** para futuros procesos de compra verde.
- **Aumentar la calidad** del producto/servicio.

Advantages.

The **Ecodesign** certification offers the possibility of:

- Anticipating regarding the compliance with current **environmental legislation**.
- Accessing **new, more demanding markets**.
- **Improving the image** of the product and the company.
- Improving compliance with the requirements demanded by the interested parties (administration, customers, consumers) for a more **sustainable economy**.
- **Distinguishing (itself)** from its competitors.
- **Reducing production costs**.
- **Promoting innovative products**.
- **Standing out in a privileged way** for future green purchasing processes.
- **Enhancing the quality** of the product / service.



Eco 100



Eco 100 PL



Eco 200



Eco 200 PL



Fresh



Es 500 - Es 500 Pad



Maia



Venecia



Micra Tek - Micra Tek Pad



Micra



Las **butacas ECO** fabricadas por Euro Seating son una línea de butacas **respetuosas con el medio ambiente** siguiendo los criterios de ecodiseño de la norma UNE-EN ISO 14006 Gestión ambiental del proceso de diseño y desarrollo. El futuro y el desarrollo económico sostenible dependen del uso racional y el mantenimiento que apliquemos a nuestros recursos naturales.

EURO SEATING fabrica sus butacas respetando rigurosamente el medio ambiente en todos los procesos productivos. Estos métodos de producción suponen un valor añadido estratégico y un firme **compromiso de desarrollo eco-sostenible**. Esta filosofía, junto con el **carácter innovador** de la empresa, ha dado como resultado **materiales reciclables** en su totalidad.

ECO SEAT

- Es **innovación** gracias a la tecnología aplicada, **materiales de última generación** y diseño inspirado en la naturaleza.
- Está **comprometido con el medio ambiente**, es un producto alternativo para todos aquellos que valoren el uso de los recursos naturales.
- **Nuestra butaca es totalmente reciclable**: tanto su estructura interna (espuma y bastidor) como en su estructura externa (costados, brazos y carcasas de asiento y respaldo).
- Piensa en el futuro y en la posibilidad de **reutilizar los componentes de la butaca** en las renovaciones de las salas.

*ECO seat by EURO SEATING constitutes a seating range **environmentally friendly** following the ecodesign criteria complying with UNE-EN ISO 14006 Environmental management of design and development. The future and sustainable economic development depend on the rational use and maintenance that we apply to our natural resources.*

*EURO SEATING manufactures its seats by respecting the environment in all production processes rigorously. These production methods imply a strategic added value and a firm **commitment to eco-sustainable development**. This philosophy, together with the company's **innovative nature**, has issued in **materials totally recyclable**.*

ECO SEAT

- *Is **innovation** due to the technology applied, **cutting-edge materials** and a design inspired in nature.*
- *Is **committed to the environment**. This is an alternative product for all those ones who appreciate the use of natural resources.*
- ***Our seat is totally recyclable**: both its internal structure (foam and internal frame) and its external structure (side panels, armrests and shells of seat pan and backrest).*
- *Has been created by thinking of the future and the possibility to **reuse the component parts of the seats** when making hall refurbishments.*

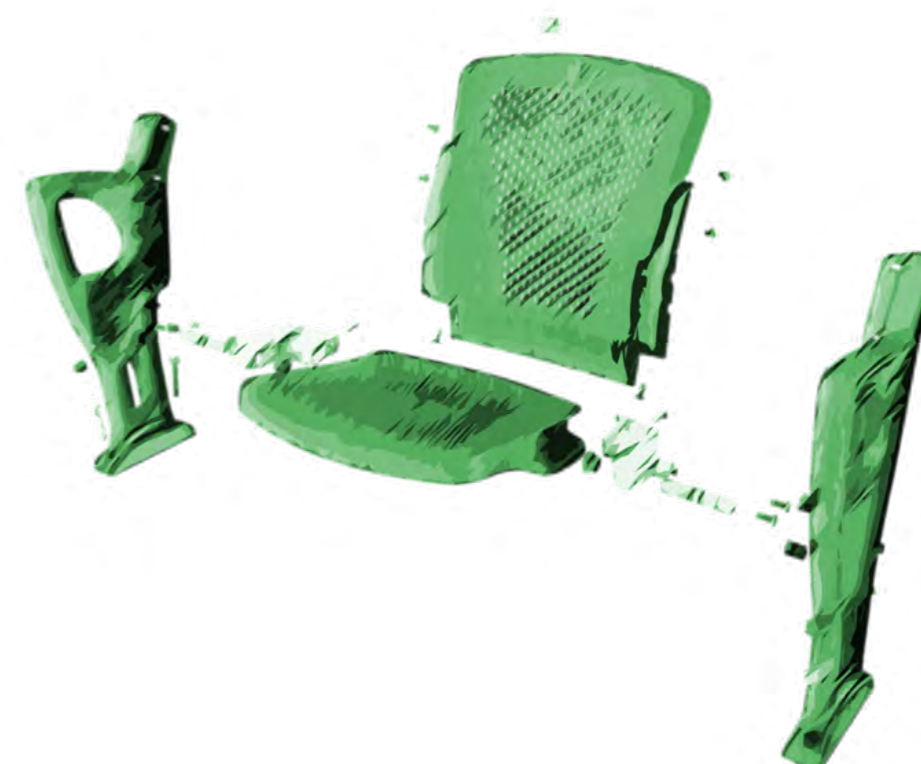



SOSTENIBLE
SUSTAINABLE



INNOVACIÓN
INNOVATION



RECICLABLE
RECYCLABLE

La naturaleza nos ha inspirado para crear un **producto de nueva generación** a su imagen y semejanza. Fiel a la materia original, la madera, en sus texturas, en su colores y acabados, y con **cualidades excepcionales al conseguir contribuir a la preservación del medio ambiente**, de nuestros bosques y nuestro entorno **sustituyendo la madera natural por materiales plásticos de alta calidad reciclables**, ecodiseñados y duraderos en el tiempo.

Una butaca excepcional con **valores muy superiores a las de fabricación tradicional**, tanto por su apariencia y estructura, como por la versatilidad que admite en su diseño.

Una butaca donde asentar el futuro.

Nuestra butaca tiene tantas vidas como queramos darle. La estructura de la butaca (pies, brazos y carcassas) permanece mientras sustituimos los cojines de asiento y respaldo todas las veces que sean necesarias. Las reformas y cambios de decoración son ahora más rápidas y económicas. **Tanto la espuma, como el tejido y la estructura interna del asiento y respaldo están fabricados en materiales reciclables.**



*Nature has inspired us to create a **product of the new generation**. Faithful to the original - wood - in its textures, colors and finishes, high quality plastic replaces natural wood, **contributing to the conservation of our forests and our environment replacing natural wood with high quality recyclable plastic materials**, ecodesigned and sustainable over time.*

*We have created an **exceptional seat with many more advantages** in terms of structure, look and versatility of design.*

A seat on which to build the future.

*Our seat has as many lives as you want to give it. The structures of the seat (standards, arms and shells) remain while you can change the seat and backrest cushions as often as necessary. Refurbishment and changes in decoration can now be done more quickly and economically. **Both the foam padding and fabric and the seat and backrest's internal structure are made of recyclable materials.***

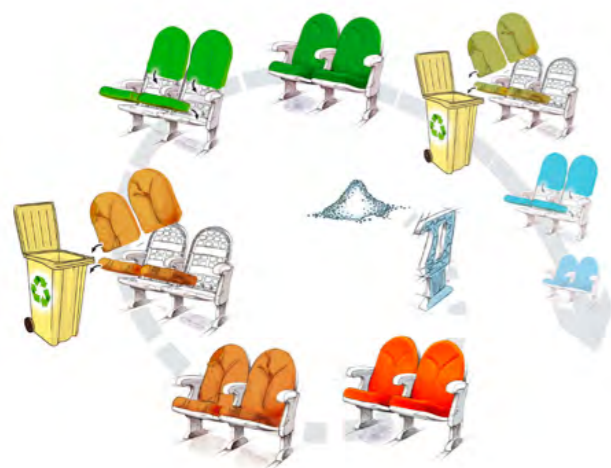

INSPIRADA EN LA NATURALEZA
INSPIRED BY NATURE



Eco 100

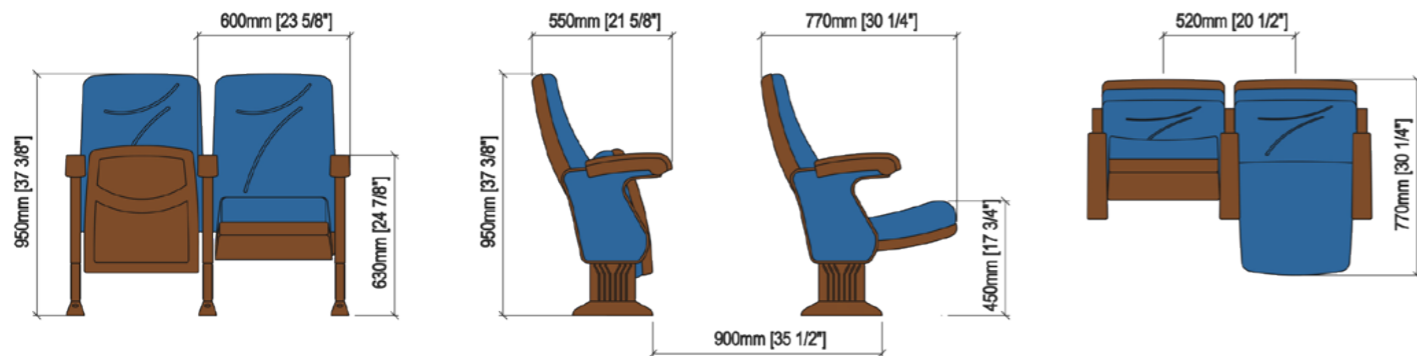

Eco 100 Pl

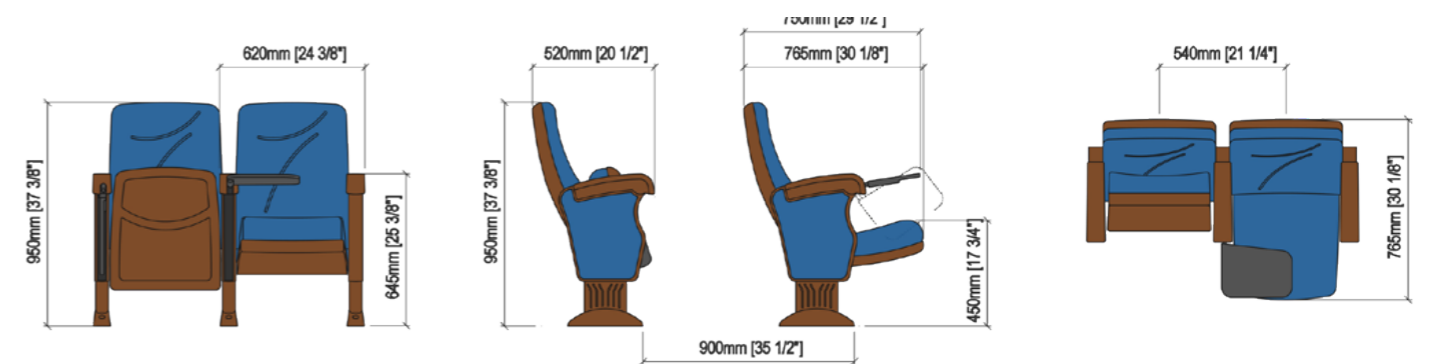

Eco 200

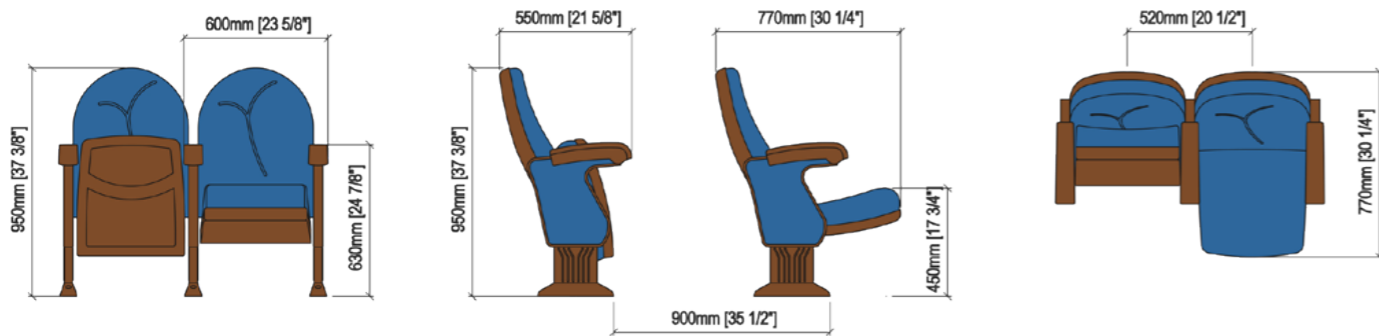



Eco 200 PL

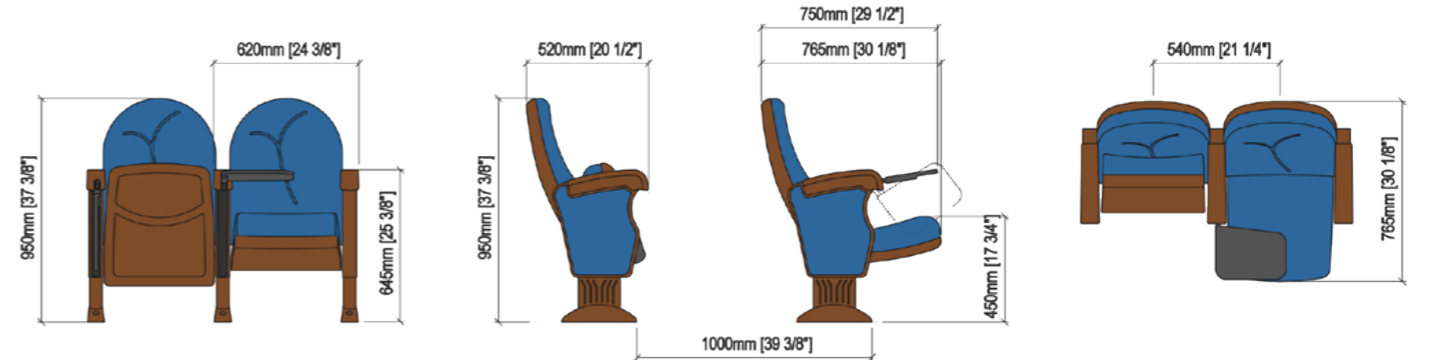



INSPIRADA EN LA NATURALEZA
INSPIRED BY NATURE



Natural / *Natural* · P 01



Avellana / *Hazelnut* · P 02

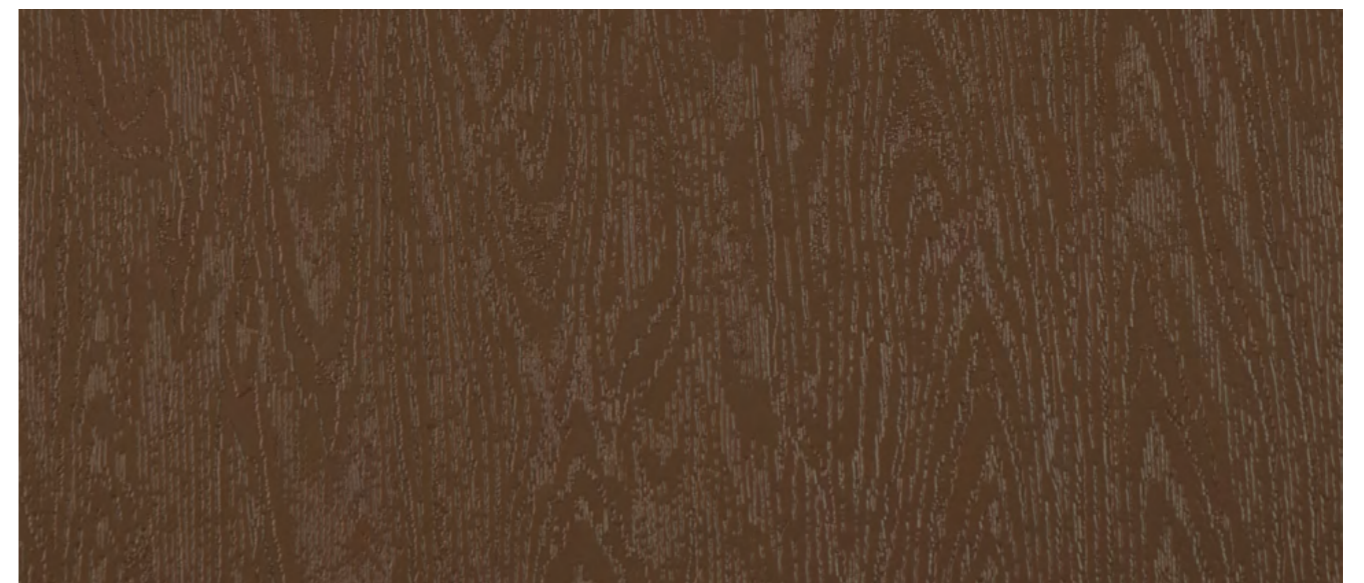

Nogal / *Walnut* · P 03





Fresh



Suelo To the floor Frente Grada Riser-Fixed Bancada Beam-Mounted Pendiente 4% Slope 4% Móvil Movable Seat Sin Brazo No Armrest

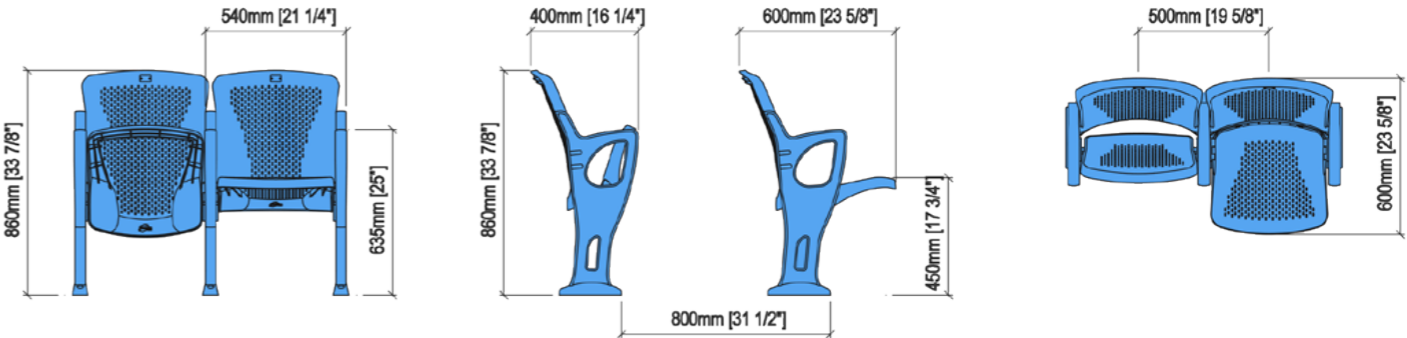

Es 500 - Es 500 Pad

Arena Hockey St. Rock. Montreal · CANADA



- 

Suelo
To the floor
- 

Frente Grada
Riser-Fixed
- 

Bancada
Beam-Mounted
- 

Pendiente 4%
Slope 4%
- 

Móvil
Movable Seat
- 

Sin Brazo
No Armrest

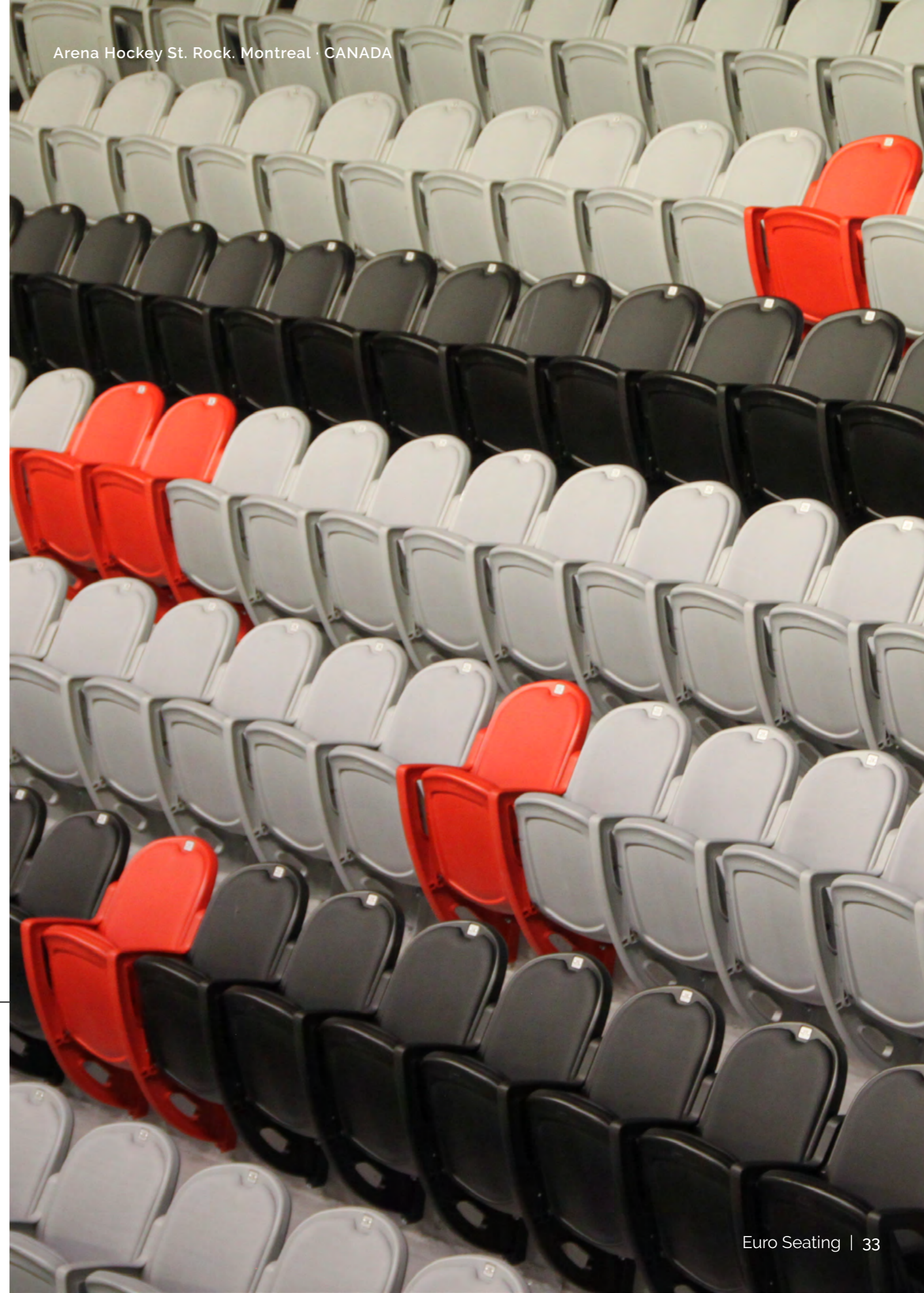
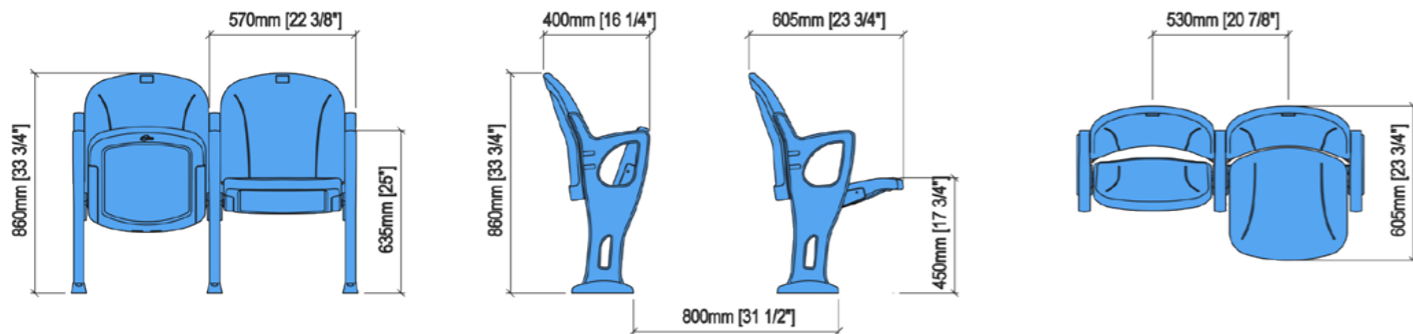



Maia



- Suelo
To the floor
- Frente Grada
Riser-Fixed
- Bancada
Beam-Mounted
- Pendiente 4%
Slope 4%
- Móvil
Movable Seat
- Sin Brazo
No Armrest

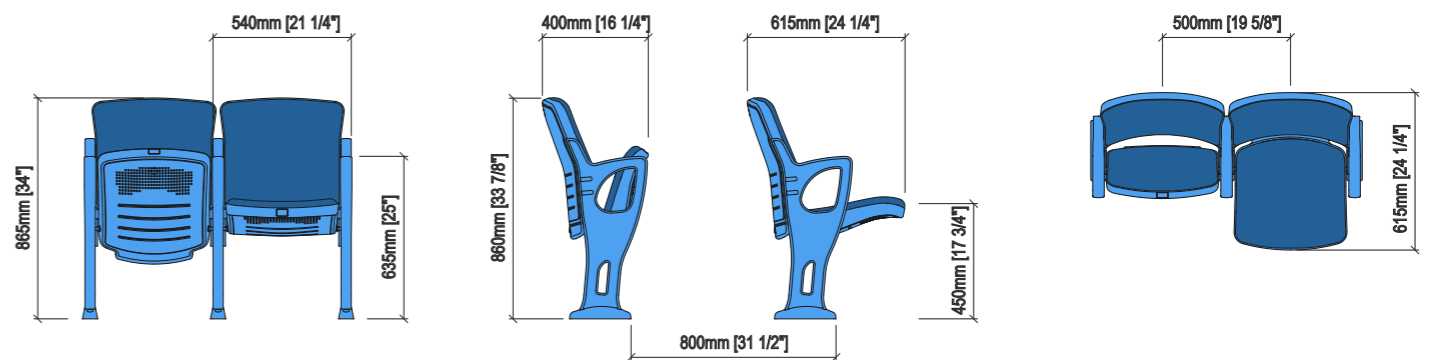

Venecia

Micra Tek - Micra Tek Pad

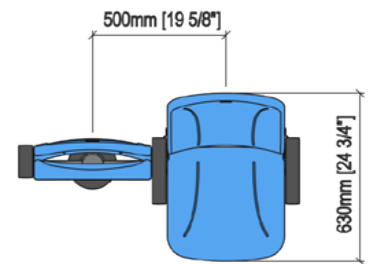
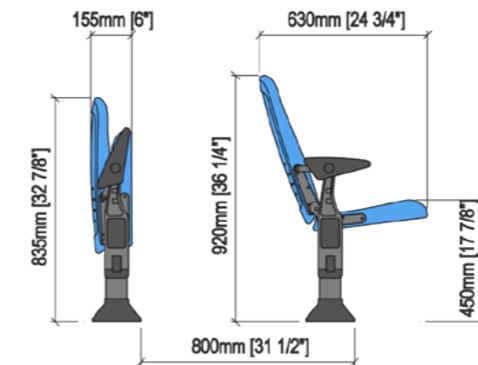
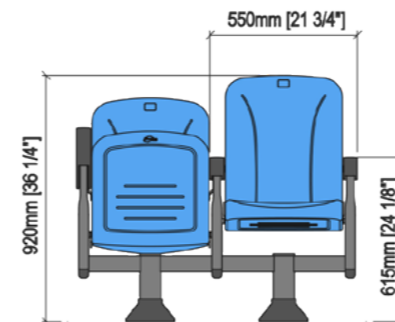
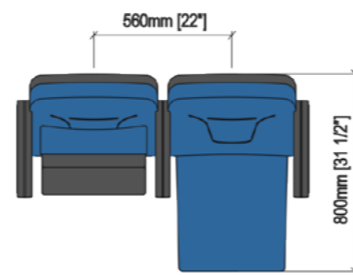
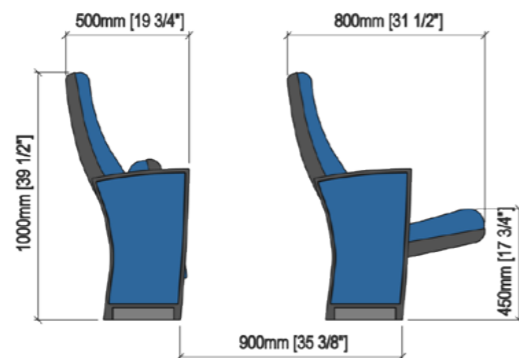
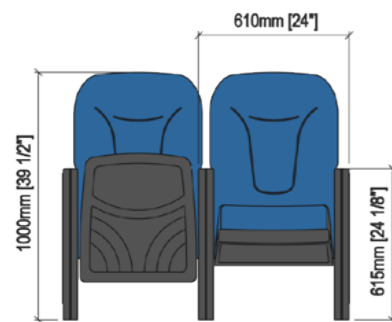



Micra



- 
 Suelo
To the floor
- 
 Frente Grada
Riser-Fixed
- 
 Sobre Grada
On-Steps
- 
 Pendiente
Slope
- 
 Móvil
Movable Seat
- 
 Abatible
Foldable Seat Frontwards

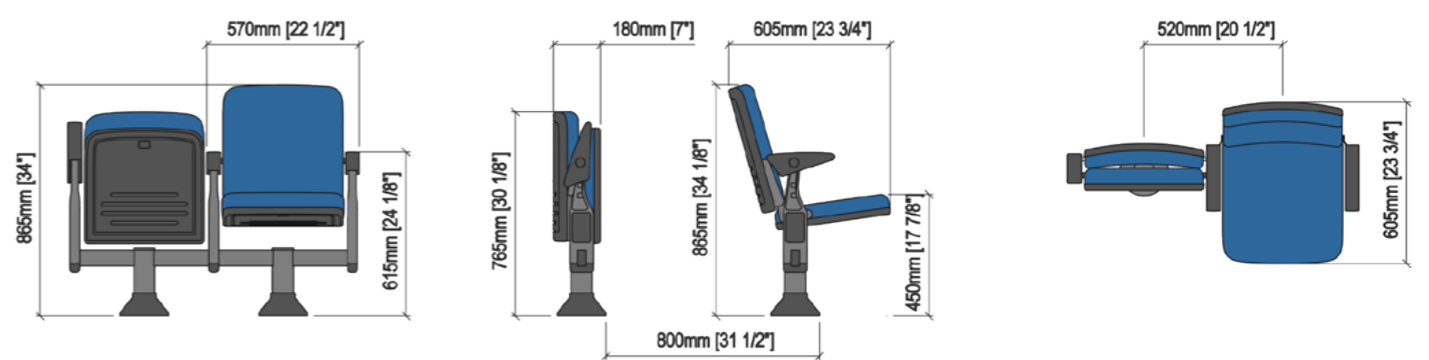



COLORS · SEAT

**EURO SEATING
RAINBOW SERIES**

**INSPIRADA EN LA NATURALEZA
*INSPIRED BY NATURE***



COLORS SEAT

EURO SEATING
RAINBOW SERIES

La gama COLORS ofrece un amplio abanico de posibilidades de butacas en polipropileno inyectado de alta calidad, tanto en texturas como en acabados y combinaciones cromáticas.

El diseño de la gama COLORS refleja un estilo propio y vanguardista a través de una estética rompedora con colores y texturas atrevidos y una creatividad impactante que capta la atención de los sentidos, incluso la de aquellos más exigentes.

La estética de las butacas COLORS cautiva a todo aquel que las contempla mediante una agradable sinestesia que fusiona tonalidades cromáticas y texturas, combinaciones inesperadas, divertidas, elegantes y armoniosas.

COLORS SEAT

- Combinaciones decorativas con **calidad en diseño y materiales**.
- Transformamos un concepto en formas, líneas y colores.
- Pone de manifiesto el carácter innovador y la total flexibilidad que ofrece EURO SEATING, haciendo posible la creación de una **butaca con personalidad propia** y sorprendente y que **se adapta completamente a los deseos del cliente** cuidando hasta el más mínimo detalle.
- Lo que nuestros sentidos alcanzan, nuestra mente lo interpreta

Los juegos decorativos entre butacas y Sala son todo un reto. **La gama cromática de los asientos abre un abanico de posibilidades** que sin duda pueden sorprender al espectador. En cualquier posible escenario, lo invariable siempre será la **calidad del diseño y los materiales** de cada butaca.

Nuestra línea COLORS-INTENSE es un homenaje a quienes no tienen miedo a la creatividad. Son butacas pensadas sobre combinaciones atrevidas de color. Son un premio a la idea y también a la coherencia de nuestros diseñadores.

COLORS offers a very wide seating range in high-quality injected polypropylene, both regarding textures and finishes as well as colours combinations.

The COLORS range conveys an outstanding avant-garde style through a ground-breaking aesthetics, daring colours and textures and a striking creativity which gets all your attention, even the attention of the most demanding ones.

The aesthetics of the COLORS seats captivates anyone who gazes at them by means of a pleasant synaesthesia which merges colour shades and textures, unexpected, enjoyable, smart and harmonious combinations.

COLORS SEAT

- *Decorative combinations by means of quality materials and great design.*
- *We turn a concept into a depiction of forms, lines and colours.*
- *Highlights the innovative nature and full flexibility that EURO SEATING offers, thus making possible the creation of a seat showing its own and surprising personality and which completely adapts to the customer's requirements, paying attention to every small detail.*
- *Perceived by our senses, interpreted by our mind.*

The play in the decoration between seats and halls is a real challenge. The spectrum of shades of the seats opens up new possibilities that undoubtedly surprise the spectator. In any possible setting, the unchanging thing will always be the quality of the design and the materials of each seat.

Our COLORS-INTENSE line is a tribute to those who are not afraid of creativity. They are seats based on provocative combinations of colours. They are a reward for the idea and also for the coherence of our designers.





Eco 100 Colors



Eco 200 Colors



Eco 200 Colors

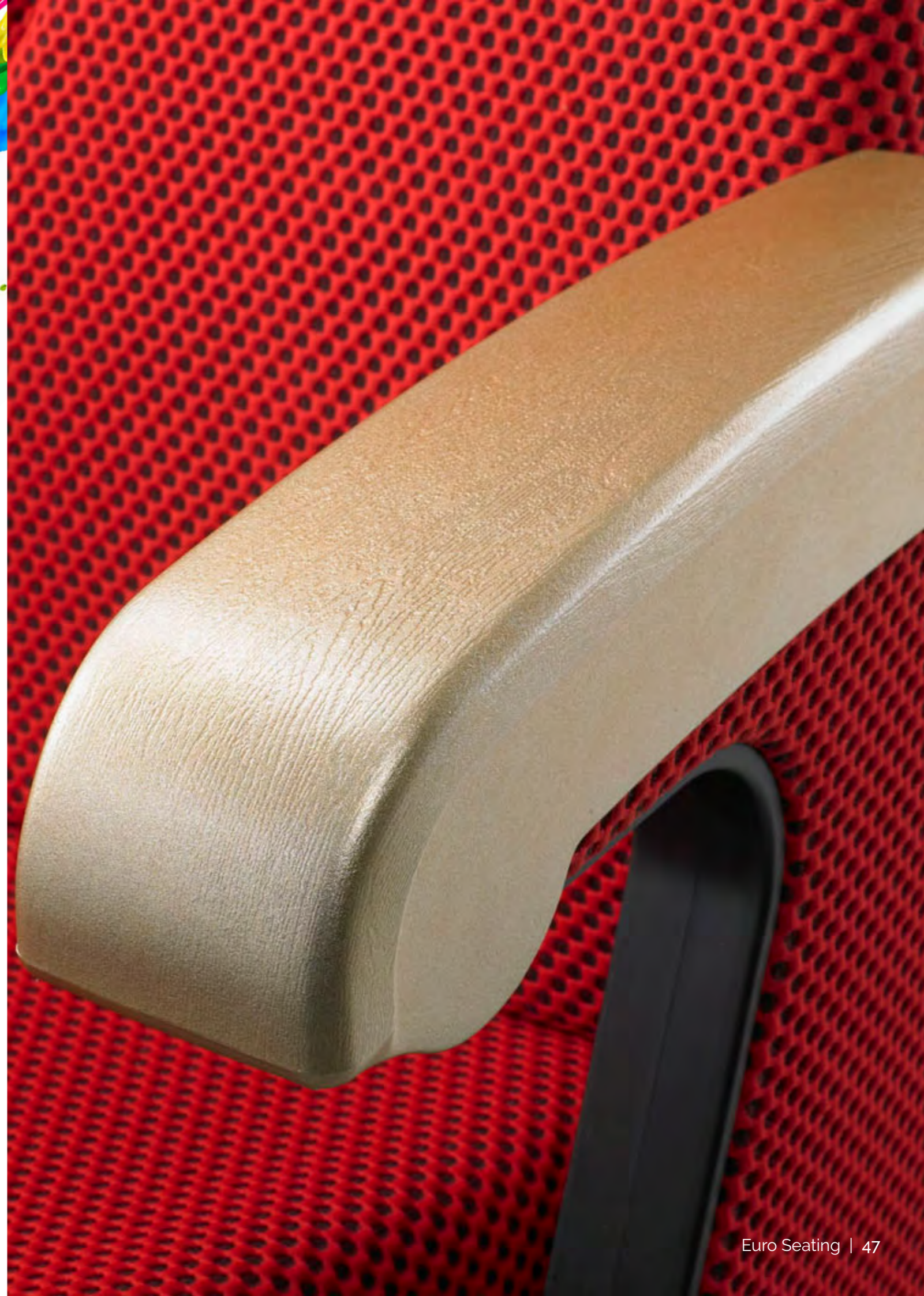



Eco 200 Colors



Eco 100 Colors



Eco 100 Colors

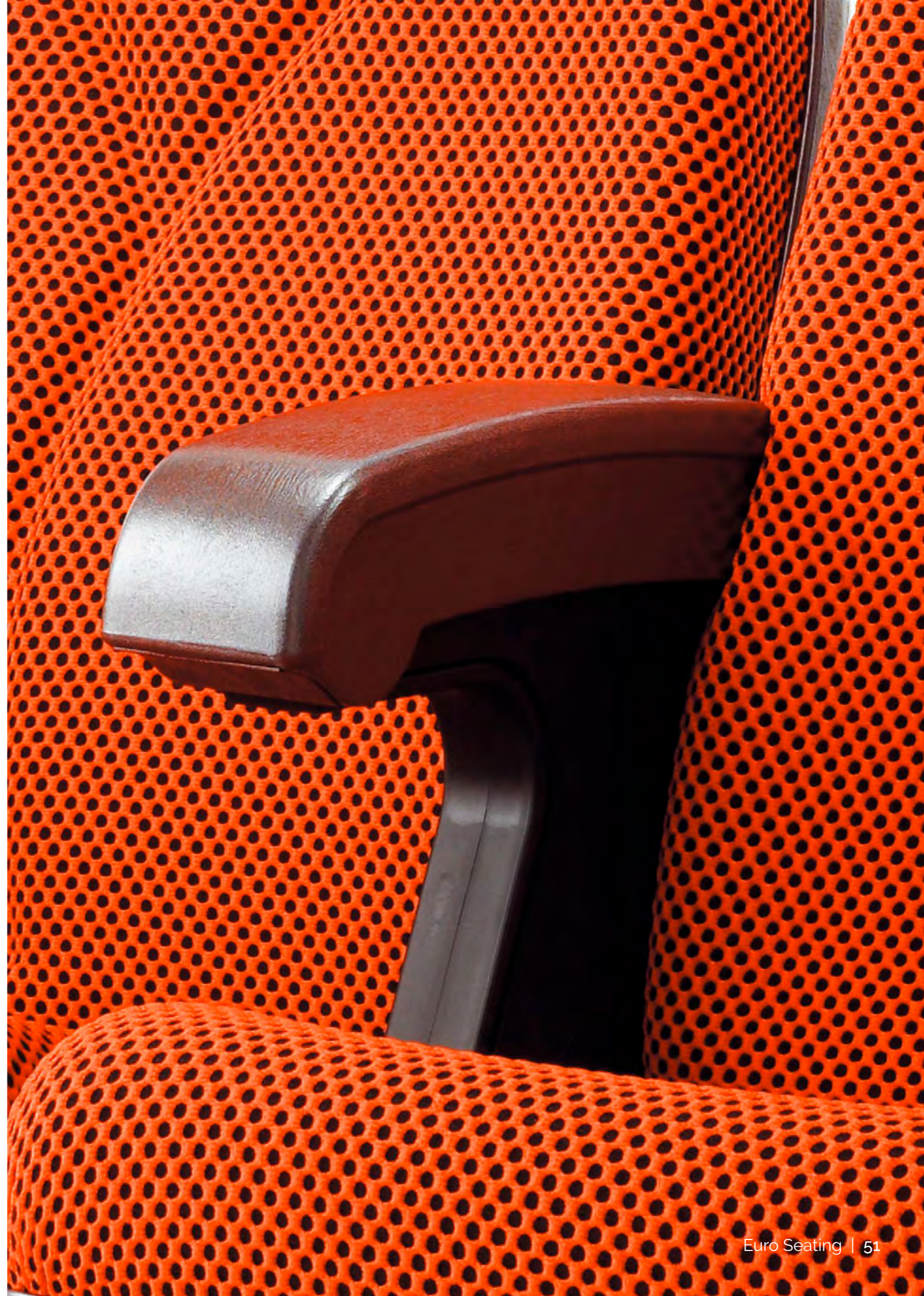



Eco 200 Colors



COLORS SEAT

EURO SEATING
RAINBOW SERIES

INSPIRADA EN LA NATURALEZA
INSPIRED BY NATURE





00

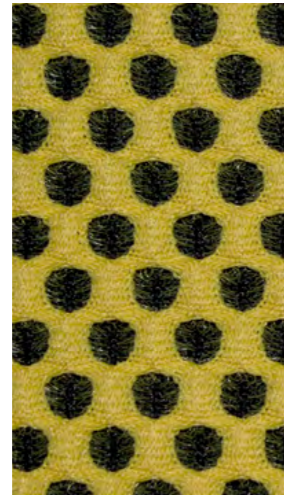

02



05



08



09

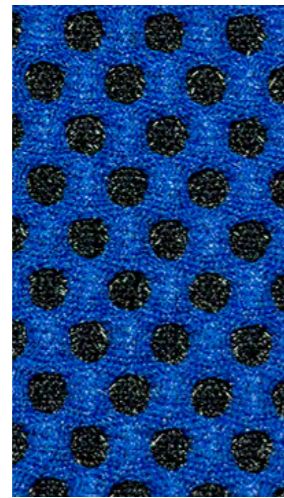

10

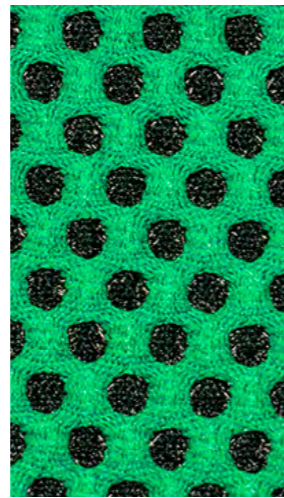

11



12



13



14

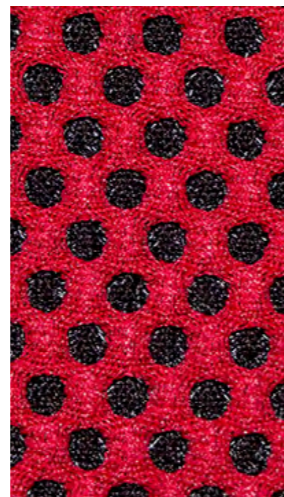

15



16



Doble frontura (Rashell)
With double relief (Rashell)



Tridimensional
Tridimensional



PES
Poliéster ignífugo
Fireproof polyester



Ancho: 150 cm
Composición: 100% polyester ignífugo
Gramaje: 325 gr/m²
Martindale > 50.0000 ciclos
Clasificación al fuego: M-1, C-1, EN-10201-1-2, BS. 5852

Width: 150 cm
Composition: 100% fireproof polyester
Grammage: 325 gr/m²
Martindale > 50.0000 cycles
Flammability: M-1, C-1, EN-10201-1-2, BS. 5852



P 10



P 11



P 12



P 13

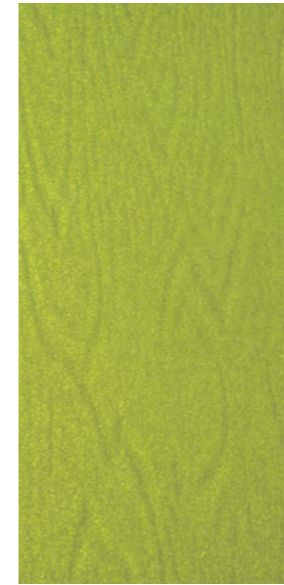

P 14



P 15



P 16



P 17



P 18



P 19



P 20

Due to restrictions related to screens and printing techniques, the colours and textures shown in this catalogue might slightly differ from the real colours and textures of the upholstery fabrics and finishes



Apaga el gris de tu vida y enciende los

colores

que llevas dentro.”

(Pablo Picasso)

“Turn the grey colour of your life off and turn the brighter

colours

you have inside on.”

(Pablo Picasso)



**EURO SEATING
HEADQUARTERS**

Polígono el Ram, nº 11
26280 Ezcaray, La Rioja
España
Tel.: +34 941 427 450
Fax: +34 941 427 218
euroseating@euroseating.com
www.euroseating.com

EURO SEATING AMERICA

Ctr. Tlajomulco – San Isidro Mazatepec nº 615 F
45640 Santa Cruz de las Flores, Jalisco
México
Tel.: +34 941 427 450
Fax: +34 941 427 218
euro.seating@euroseating-america.com
www.euroseating-america.com



SPAIN · MEXICO · GERMANY · PORTUGAL · UK · RUSSIA · QATAR · SINGAPORE · SAUDI ARABIA · CANADA · BRAZIL